

THE FOOD PACKAGING SPECIALISTS

- ▢ Termosaldatrici alimentari
- ⊗ Food thermosealing machines
- ▣ Schalensiegler für Lebensmittel

MADE IN ITALY
JPACK
Packaging Machines

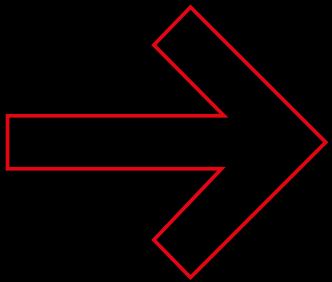



01.

- 🏠 Termosigillatrici da banco
- 🌀 Table-top thermosealing machines
- 📦 Tischschalensiegelgeräte

02.

- 🏠 Termosigillatrici MAP
- 🌀 MAP thermosealing machines
- 📦 Schalensiegelgeräte in MAP

03.

- 🏠 Termosigillatrici SKIN
- 🌀 SKIN thermosealing machines
- 📦 Schalensiegelgeräte in SKIN

JPACK
Packaging Machines

 **ATTENZIONE**
NON INSERIRE LE MANI ALL'INTERNO DELLA MACCHINA 
WARNING
DO NOT PUT YOUR HANDS INSIDE THE MACHINE 



🏠 **Quella di J Pack è una storia tutta italiana, che racconta il saper fare proprio di una terra e la dedizione al lavoro di una famiglia.**

🕒 **J Pack's is a 100% Italian story, which tells of a land's know-how and a family's dedication to work.**

📄 **Die rein italienische Geschichte von J Pack erzählt vom Know-how eines Gebiets und vom Fleiß einer Familie.**

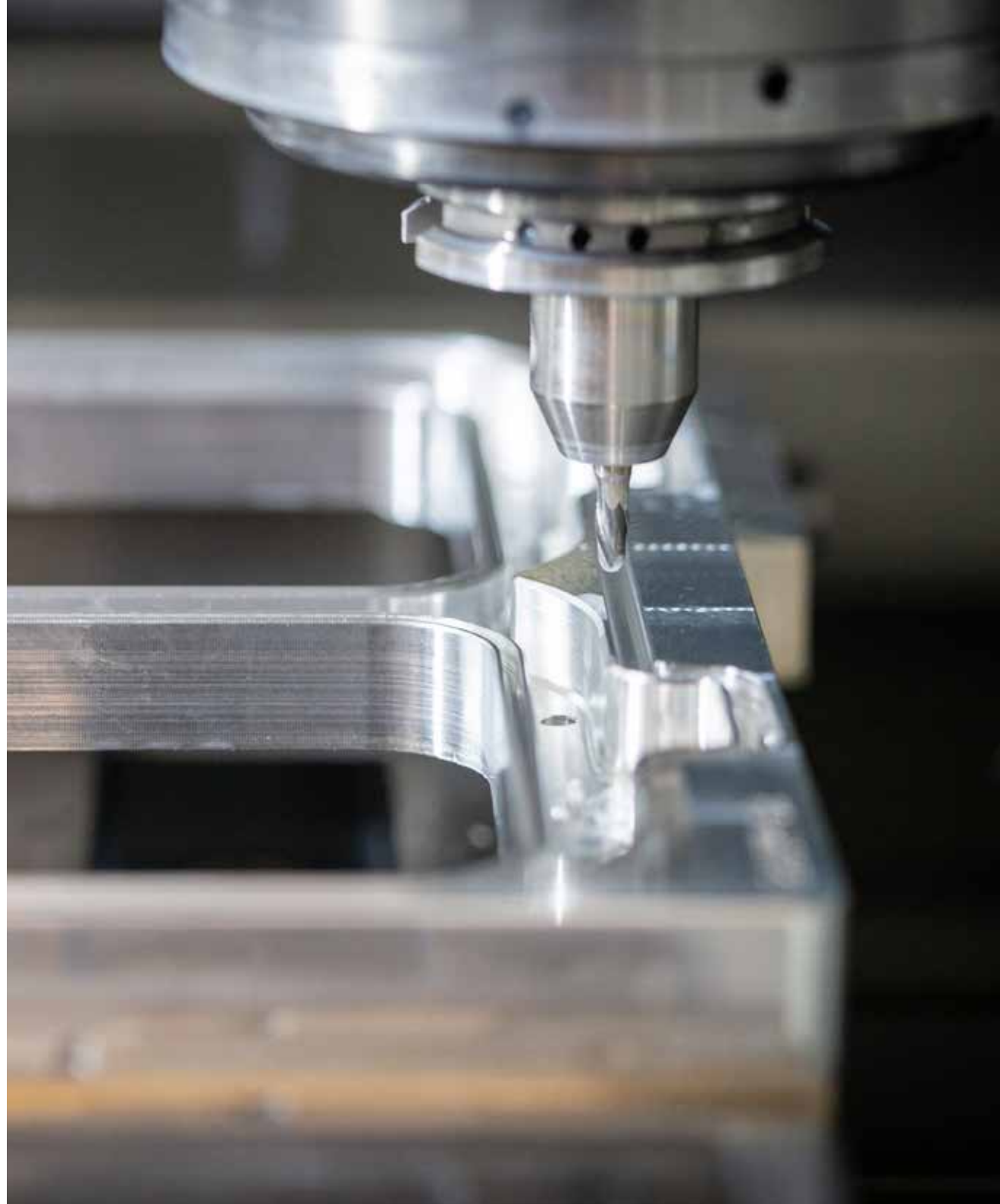

- 🏠 **J Pack - una storia tutta italiana**
- 🕒 **J Pack - a 100% made-in-Italy story**
- 📄 **J Pack - eine rein italienische Geschichte**

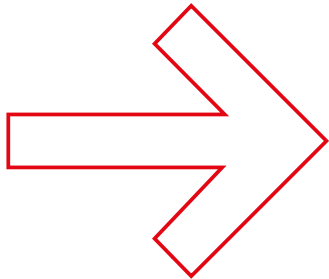

🏠 Negli anni '70 Carlo Salvi, tecnico ingegnere, spinto dalla passione per la meccanica, decide di fondare la sua attività: una piccola officina destinata a un grande futuro. Da subito si mise al servizio dell'industria del packaging sviluppando meccanica di precisione a impiego industriale. Il rapido sviluppo e la creazione di una più grande unità produttiva coincisero con

l'ingresso in azienda dei figli Pierbattista, Giovanna e Alessandro. A metà degli anni '90, le competenze acquisite diedero lo spunto per ideare una prima gamma di termosigillatrici e sviluppare i primi brevetti aziendali. Da lì l'ascesa ai mercati internazionali. I continui investimenti in ricerca e sviluppo uniti alle competenze sviluppate in 40 anni di lavorazioni meccaniche, hanno contribuito alla crescita dell'Azienda ed hanno reso J Pack un esempio del Made in Italy, un marchio riconosciuto a livello mondiale.

🕒 In 1970s Mr. Carlo Salvi, technical engineer, decided to found his business: a small workshop destined, however, to a great future. Since the very start, Mr. Salvi had served the packaging industry with his expertise, developing precision mechanics for industrial use. Joined by Pierbattista, Giovanna and Alessandro, the founder's

children, the company experienced fast-paced development and added to its assets a larger production unit. By the 1990s, skills honed inspired the design of an initial range of thermosealing machines and the development of the first corporate patents. From there, the company marked its entrance on international markets. Continuous investments in research and development combined with the know-how honed over 40 years of mechanical processing, have contributed to the company's growth, making J Pack a paragon of Made-in-Italy excellence and a brand recognized worldwide.

📄 Am Ende der 70iger Jahre beschloss Carlo Salvi, technischer Ingenieur, wegen seiner Leidenschaft für die Mechanik ein eigenes Unternehmen zu gründen. Es handelte sich um eine kleine Werkstatt, der aber eine große Zukunft bevorstand. Er widmete sich sofort

der Verpackungsindustrie und entwickelte Präzisionsmechanik für Industrieanwendungen. Die rasche Entwicklung und die Eröffnung einer größeren Produktionseinheit kam, als seine Kinder Pierbattista, Giovanna und Alessandro im Unternehmen zu arbeiten begannen. Mitte der 90iger Jahre führten die erworbenen Fähigkeiten zur Entwicklung der ersten Schalensiegelgeräte und zu den ersten Patenten des Unternehmens.

Ab diesem Zeitpunkt begann der Auftritt auf dem internationalen Markt. Die ständigen Investitionen in Forschung und Entwicklung haben gemeinsam mit dem erworbenen Know-how während der 40-jährigen Tätigkeit im Bereich der mechanischen Bearbeitungen zum Wachstum des Unternehmens beigetragen und J Pack zu einem Beispiel des Made in Italy und einer weltweit anerkannten Marke gemacht.



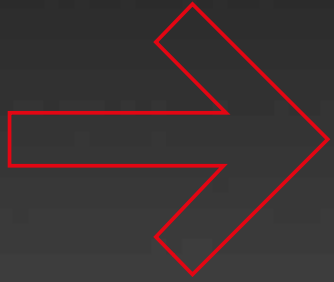

🏠 La nostra quarantennale esperienza nel settore ci ha permesso di sviluppare una solida competenza tecnica. Il nostro saper fare meccanico e progettistico ci consente di mantenere alti standard qualitativi ed un'attenzione particolare alle specifiche esigenze del cliente. La nostra esperienza ci ha permesso di sviluppare molteplici soluzioni in funzione della tipologia di prodotto da sigillare.



🕒 The experience we gained over forty years in the food packaging sector has allowed us to develop solid technical skills. Our mechanical and engineering know-how allows us to maintain high-quality standards and pay particular attention to our customers' needs. Our experience has allowed us to develop multiple solutions, based on the type of product to be sealed.



📦 Unsere 40-jährige Erfahrung im Verpackungsbereich hat es uns ermöglicht, starke technische Kompetenzen aufzubauen. Unser Know-how im Bereich Mechanik und Ingenieurwesen erlaubt es uns, hohe Qualitätsstandards zu erhalten und den Bedürfnissen unserer Kunden besondere Aufmerksamkeit zu widmen. Unsere Erfahrung gab uns die Gelegenheit, zahlreiche Lösungen nach den zu versiegelnden Produkten zu entwickeln.





01.

- 🏠 **Termosigillatrici da banco**
- 🕒 **Table-top thermosealing machines**
- 📦 **Tischschalensiegelgeräte**



deli and food service industry. The range goes from the electric tabletop machines easy to install, up the semiautomatic models with die-cut. We offer a wide range of trays and films especially conceived for granting the maximum product freshness. They are suitable for our patented modular mould INFINITY.

📦 Wir haben eine Linie von Schalensiegeln entworfen, die die Bedürfnisse an Flexibilität und Produktionsoptimierung der Supermärkte, Gastronomiebetriebe und Restaurants erfüllen können. Diese Palette enthält elektrische und einfach zu installierende Tischmaschinen, die ideal für jede Anwendung sind, bis zu halbautomatischen Maschinen mit Folienausstanzformen. Wir bieten eine breite Auswahl an Schalen und Folien, die für maximale Frische sorgen und mit unserer patentierten modularen Form INFINITY kompatibel sind.

🏠 Abbiamo sviluppato una linea di termosigillatrici capaci di rispondere alle esigenze di flessibilità e ottimizzazione produttiva di supermercati, gastronomie e ristorazione.

Questa gamma include macchine da banco elettriche e facili da installare, ideali per ogni applicazione, fino ad arrivare a modelli semi-automatici con stampi fustellati. Disponiamo

di un'ampia scelta di vaschette e film pensate per garantire la massima freschezza, compatibili con il nostro stampo modulare brevettato INFINITY.

🕒 We developed a range of thermosealing machines conceived for satisfying the need for flexibility and production optimization of supermarkets,



Termostigillatrici elettriche manuali

Manual electric thermosealing machines

Manuelle elektrische Schalsiegelgeräte

▷ Pannello di controllo intuitivo

- ⊗ Intuitive control panel
- ☐ Intuitives Bedienfeld

▷ Ampia superficie saldante

- ⊗ Wide sealing plate
- ☐ Große Schweißplatte

▷ Cutter frontale per taglio film (optional)

- ⊗ Frontal cutter for film (optional)
- ☐ Frontales Trennmesser für Folien (Optional)

▷ Microperforatore film (optional)

- ⊗ Film micropuncher (optional)
- ☐ Mikroperforierungseinheit für Folie (Optional)

▷ Cambio stampo rapido senza attrezzi

- ⊗ Fast mould change without tools
- ☐ Schneller Werkzeugwechsel ohne Geräte

▷ Stampi su misura e stampo modulare personalizzato INFINITY

- ⊗ Customised moulds and patented modular mould INFINITY
- ☐ Personalisierte Formen und patentierte modulare Form INFINITY

▷ Segnale acustico e visivo di fine ciclo

- ⊗ End of cycle visual and acoustic signal
- ☐ Zyklus Beendung mit akustischem und optischem Signal

▷ 5 programmi memorizzabili

- ⊗ 5 customizable sealing programs
- ☐ 5 anpassbare Verpackungsprogramme

▷ Leva con sistema "Click-n-Pack"

- ⊗ Handle with "Click-n-Pack" system
- ☐ Hebel mit System „Click-n-Pack“

▷ Dimensioni compatte

- ⊗ Compact sizes
- ☐ Kompakte Abmessungen

▷ Movimentazione elettrica

- ⊗ Electric handling
- ☐ Elektrische Handhabung

▷ Installazione rapida

- ⊗ Rapid installation
- ☐ Schnelle Installation

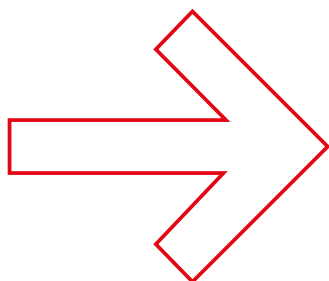

TSM105-R

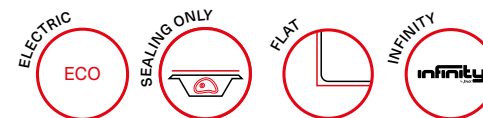

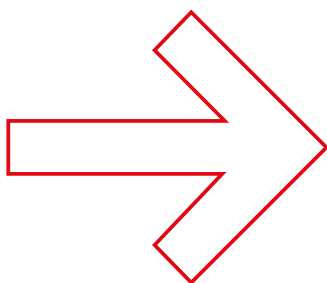

△ La nostra gamma di termosigillatrici elettriche manuali da banco si caratterizza per compattezza e versatilità. L'innovativo sistema "Click-n-Pack" facilita l'utilizzo della leva di attivazione ciclo. È possibile abbinare alla macchina lo stampo modulare INFINITY oppure stampi personalizzati.

⊙ Our manual tabletop machines range stands out for its compact sizes and versatility. The innovative "Click-n-Pack" system simplifies the use of the handle that activates the cycle. It is possible to combine the machine with the modular mould INFINITY or customized moulds.

☐ Unsere Palette von elektrischen Tischschalensiegleren zeichnet sich durch Kompaktheit und Vielseitigkeit aus. Das innovative System „Click-n-Pack“ erleichtert die Nutzung des Hebels, der den Verpackungszyklus aktiviert. Es ist möglich, die Maschine mit der modularen Form INFINITY oder mit personalisierten Formen zu vervollständigen.



Modello	Model	Modell	TSM101-R	TSM102-R	TSM105-R
Dim. macchina / Peso	Machine sizes / Weight	Größe / Gewicht	260 x 390 h 500 mm / 20 kg	315 x 450 h 555 mm / 25 kg	485 x 510 h 555 mm / 35 kg
Voltaggio assorbimento	Voltage absorption	Spannung Absorption	230 V - 0,5 kW	230 V - 0,7 kW	230 V - 1,4 kW
Dim. max vaschette	Tray max sizes	Max. Schalengröße	150 x 205 h 100 mm	195 x 260 h 155 mm	280 x 370 h 155 mm
Dimensione max film	Max reel dimension	Max Foliengröße	L= 150 - Ø 160 mm	L= 210 - Ø 200 mm	L= 380 - Ø 200 mm
Cicli/minuto	Cycles/minute	Zyklen/Minute	3-8	3-8	3-8
Optional	Optional	Optional		△ Cutter frontale ⊙ Frontal cutter ☐ Frontales Trennmesser	△ Cutter frontale ⊙ Frontal cutter ☐ Frontales Trennmesser

Termostigillatrici elettriche semiautomatiche

Semi-automatic electric thermosealing machines

Halbautomatische elektrische Schalsiegelgeräte

▢ Pannello di controllo intuitivo

- ⊗ Intuitive control panel
- ▢ Intuitives Bedienfeld

▢ Contaccli

- ⊗ Cycles-counter
- ▢ Zyklenzähler

▢ 9 programmi memorizzabili

- ⊗ 9 customizable sealing programs
- ▢ 9 anpassbare Verpackungsprogramme

▢ Dimensioni compatte

- ⊗ Compact sizes
- ▢ Kompakte Abmessungen

▢ Movimentazione elettrica

- ⊗ Electric handling
- ▢ Elektrische Handhabung

▢ Installazione rapida

- ⊗ Rapid installation
- ▢ Schnelle Installation

▢ Segnale acustico e visivo di fine ciclo

- ⊗ End of cycle visual and acoustic signal
- ▢ Zyklus Beendung mit akustischem und optischem Signal

▢ Microperforatore film (optional)

- ⊗ Film micropuncher (optional)
- ▢ Mikroperforierungseinheit für Folie (Optional)

▢ Cutter frontale per taglio film (optional)

- ⊗ Frontal cutter for film (optional)
- ▢ Frontales Trennmesser für Folien (Optional)

▢ Lavaggio gas (optional)

- ⊗ Gas flushing (optional)
- ▢ Gasspülung (Optional)

▢ Cambio stampo rapido senza attrezzi

- ⊗ Fast mould change without tools
- ▢ Schneller Werkzeugwechsel ohne Geräte

▢ Stampi su misura e stampo modulare personalizzato INFINITY

- ⊗ Customised moulds and patented modular mould INFINITY
- ▢ Personalisierte Formen und patentierte modulare Form INFINITY

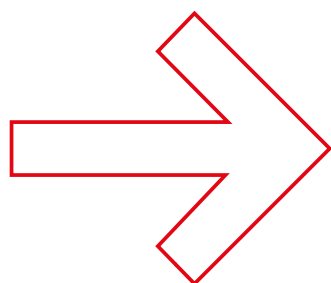

TSS102-R

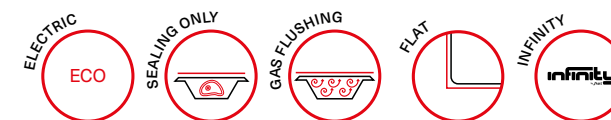



△ Grazie alle misure compatte e alla rapidità del cambio stampo, la gamma di termosigillatrici elettriche semiautomatiche da banco è la soluzione ideale per gastronomie, supermercati e delivery. È possibile realizzare stampi su misura, oppure utilizzare il nostro sistema INFINITY. L'opzione lavaggio è disponibile su 102 e 105.

⊙ Thanks to its compact sizes and the fast mould change, the electric semiautomatic thermosealing machines range represents the ideal solution for deli, supermarkets and deliveries. It is possible to realize custom-made tools as well as choose our INFINITY system. The gas flushing option is available for models 102 and 105.



□ Dank ihren kompakten Abmessungen und der Schnelligkeit des Werkzeugwechsels stellt die Tischschalensieglerlinie die ideale Lösung für Gastronomiebetriebe, Supermärkte und Lieferservice dar. Es ist möglich, diese Maschinen mit personalisierten Formen oder mit unserem INFINITY System zu vervollständigen. Für die Modelle TSS102-R und TSS105-R ist eine Gasspülungsoption verfügbar.

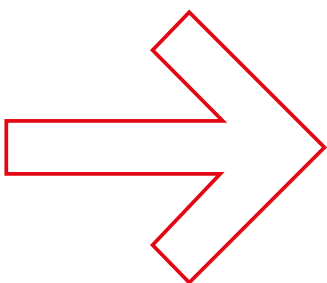

TSS101-R



TSS102-R



TSS105-R

Modello	Model	Modell	TSS101-R	TSS102-R	TSS105-R
Dim. macchina / Peso	Machine sizes / Weight	Größe / Gewicht	240 x 390 h 500 mm / 20 kg	295 x 450 h 555 mm / 25 kg	mm 460 x 510 h 555 mm / 35 kg
Voltaggio assorbimento	Voltage absorption	Spannung Absorption	230 V - 0,55 kW	230 V - 0,75 kW	230 V - 1,5 kW
Dim. max vaschette	Tray max sizes	Max. Schalengröße	150 x 205 h 100 mm	195 x 260 h 155 mm	280 x 370 h 155 mm
Dimensione max film	Max reel dimension	Max Foliengröße	L= 150 - Ø 160 mm	L= 210 - Ø 200 mm	L= 380 - Ø 200 mm
Cicli/minuto	Cycles/minute	Zyklen/Minute	3-8	3-8	3-8
Optional	Optional	Optional		△ Cutter frontale e lavaggio gas ⊙ Frontal cutter and gas flushing □ Frontales Trennmesser und Gasspülung	△ Cutter frontale e lavaggio gas ⊙ Frontal cutter and gas flushing □ Frontales Trennmesser und Gasspülung

🏠 Brevetto INFINITY

🕒 INFINITY Patent

📄 INFINITY-Patent



🏠 INFINITY è un dispositivo brevettato, nato per rispondere alle esigenze di flessibilità del comparto del confezionamento alimentare professionale, assicurando la massima efficienza e produttività. Lo stampo modulare INFINITY permette di sigillare in pochi secondi, con un'unica bobina, una vasta gamma di vaschette di dimensioni e materiali diversi (polipropilene, cartoncino, compostabile). Questa speciale applicazione è perfetta per il confezionamento di piatti pronti ed è la soluzione ideale per supermercati, gastronomie e delivery.

🕒 INFINITY is a patented device, developed to respond to the need of flexibility of the professional food packaging segment, maximizing the efficiency and the productivity. The modular mould INFINITY by one unique modular mould, one machine and a reel, allows the user to seal in few seconds a wide range of different trays sizes and materials (PP, Paper and compostable trays). This special application is perfect for the packaging of ready meals and is the ideal solution for supermarkets, deli shops and delivery.

📄 INFINITY ist ein patentiertes Gerät, das dem Bedarf an Flexibilität des professionellen Lebensmittelverpackungsbereichs entspricht und maximale Effizienz und Produktivität garantiert. Die modulare Form INFINITY ermöglicht, mit einer einzigen Modulform, einer einzigen Maschine und einer einzigen Folienrolle, in wenigen Sekunden eine breite Palette von PP-Schalen, Pappschalen oder kompostierbaren Schalen verschiedener Größe zu siegeln. Diese Spezialanwendung eignet sich perfekt für die Verpackung von Fertiggerichten und ist die ideale Lösung für Supermärkte, Gastronomiebetriebe und Lieferservice.



INFINITY 1

INFINITY 2

INFINITY PLUS

∅ Macchine ∅ Machines
 □ Maschinen

TSM101-R / TSM102-R / TSM105-R / TSS101-R / TSS102-R / TSS105-R

TSM102-R / TSM105-R / TSS102-R / TSS105-R

TSM102-R / TSM105-R / TSS102-R / TSS105-R

∅ Schema ∅ Pattern
 □ Muster

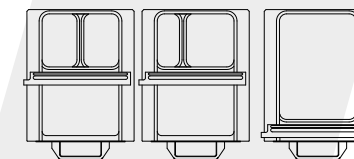
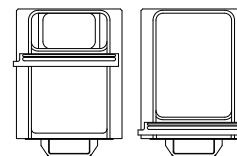
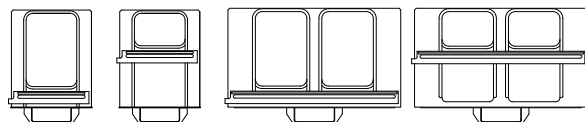

∅ Formati vaschette ∅ Trays sizes
 □ Schalengröße

137X190 / 137X125 / 137X95

260X190 / 230X190 / 137X190 / 137X95

260X190 / 230X190 / 137X190 / N°2 137X95 / 125X137

∅ Materiali ∅ Material
 □ Material

PP / Paper / BIO

PP / Paper / BIO

PP / Paper / BIO

Film ∅ Film □ Film

	Codice Code Code	Materiale Material Material	Fascia Width Band	Metri Meters Meter	Adatto a Suitable for Geeignet für		
					PP	PAPER	BIO
INFINITY 1	6FL003	PET-PP	150	200	√S		
	6FL010	PET-PE	150	200	√P	√P	√P
	6FL022	PET	150	400		√S	
	6FL090	BIO	150	200			√S
INFINITY 2	6FL004	PET-PP	200	200	√S		
	6FL006	PET-PE	200	200	√P	√P	√P
	6FL023	PET	200	400		√S	
	6FL017	PET-PE (antifog)	195	250	√P		
	6FL063	BIO	200	200			√S



PP

6VA001 / 6VA002 / 6VA003

mm 137x95x30 / 137x95x45 / 137x95x63

Tray "PP" line - P

◻ INFINITY 1, INFINITY 2, INFINITY Plus



6VA004 / 6VA005 / 6VA006 / 6VA007 / 6VA008

mm 190x137x20 / 190x137x38 / 190x137x50 / 190x137x72 / 190x137x85

Tray "PP" line - G

◻ INFINITY 1, INFINITY 2, INFINITY Plus



6VA009 / 6VA010 / 6VA011 / 6VA012

mm 230x190x25 / 230x190x35 / 230x190x50 / 230x190x65

Tray "PP" line - L

◻ INFINITY 2, INFINITY Plus



6VA013 / 6VA014 / 6VA015 / 6VA016 / 6VA017 / 6VA018

mm 260x190x20 / 260x190x35 / 260x190x50 / 260x190x65 / 260x190x85 / 260x190x95

Tray "PP" line - M

◻ INFINITY 2, INFINITY Plus



PAPER

6VA030P

Tray "Paper" line - Pmax

mm 137x125x50

◻ INFINITY 1, INFINITY Plus

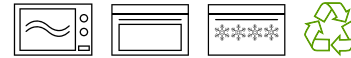

6VA031P

Tray "Paper" line - G

mm 190x137x50

◻ INFINITY 1, INFINITY 2, INFINITY Plus

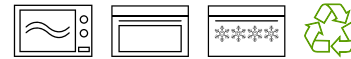

6VA032P

Tray "Paper" line - L

mm 230x190x50

◻ INFINITY 2, INFINITY Plus



6VA033P

Tray "Paper" line - M

mm 260x190x50

◻ INFINITY 2, INFINITY Plus



INFINITY Bio

△ J Pack, fin dall'inizio della sua attività, presta particolare attenzione alle questioni ambientali, sviluppando una gamma di vassoi ecologici di cartone riciclabile e residui di canna da zucchero compostabili. I vassoi compostabili sono completamente privi di olio e biodegradabili.

○ J Pack has been giving special attention to environmental issues since the beginning of its activity and has developed a range of eco friendly trays made of recyclable cardboard and compostable sugar cane residue. Our compostable trays are completely oil-free and biodegradable.

□ J Pack hat seit dem Beginn ihrer Tätigkeit auf Umweltschutz geachtet. Da wurde eine Linie von umweltfreundlichen Schalen aus recyclebarem Karton und kompostierbaren Zuckerrohrabfällen entwickelt. Unsere kompostierbaren Schalen sind völlig ölfrei und biologisch abbaubar.

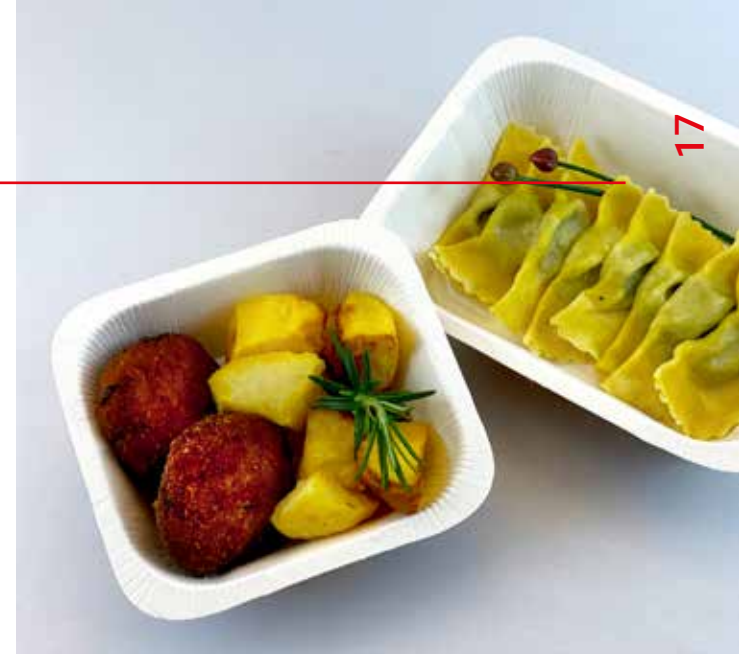

6VA030BIO

Tray "BIO" line - P max
mm 137x125x45

□ INFINITY 1, INFINITY Plus



6VA032BIO

Tray "BIO" line - L
mm 230x190x45

□ INFINITY 2, INFINITY Plus



6VA031BIO

Tray "BIO" line - G
mm 190x137x45

□ INFINITY 1, INFINITY 2, INFINITY Plus



6VA033BIO

Tray "BIO" line - M
mm 260x190x45

□ INFINITY 2, INFINITY Plus



Termosigillatrice semiautomatica elettrica con fustella

Electric semi-automatic
thermosealing machine
with die-cut

Halbautomatischer
elektrischer Schalensiegler
mit Folienausstanzung

- ▢ Pannello di controllo intuitivo
- ⊗ Intuitive control panel
- ▢ Intuitives Bedienfeld

▢ Segnale acustico e visivo di fine ciclo

⊗ End of cycle visual and acoustic signal

▢ Zyklus Beendung mit akustischem und optischem Signal

- ▢ 9 programmi memorizzabili
- ⊗ 9 customizable sealing programs
- ▢ 9 anpassbare Verpackungsprogramme

▢ Lavaggio gas (optional)

⊗ Gas flushing (optional)

▢ Gasspülung (Optional)

- ▢ Dimensioni compatte
- ⊗ Compact sizes
- ▢ Kompakte Abmessungen

▢ Ottima finitura estetica della vaschetta

⊗ Excellent aesthetic finish

▢ Ausgezeichnete ästhetische Ausführung

- ▢ Movimentazione elettrica
- ⊗ Electric handling
- ▢ Elektrische Handhabung

▢ Stampi fustellati personalizzati

⊗ Customised die-cut moulds

▢ Personalisierte Folienausstanzformen

- ▢ Installazione rapida
- ⊗ Rapid installation
- ▢ Schnelle Installation

▢ Stampo fisso

⊗ Fixed mould

▢ Feste Form

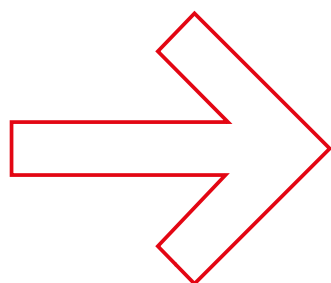

TSS102-F

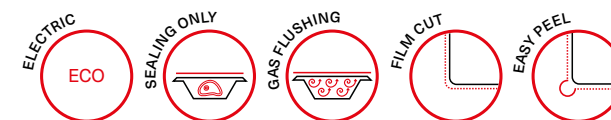

◻ Grazie al suo ingombro ridotto e allo stampo fisso fustellato personalizzato, la TSS102-F soddisfa le esigenze di chi cerca una macchina semi-automatica da banco rapida e funzionale. Il risultato è una vaschetta dall'ottima finitura estetica, perfetta per gli scaffali dei supermercati. Il lavaggio gas opzionale favorisce il mantenimento della freschezza del prodotto.

◊ Thanks to the reduced dimensions and the fixed customized die-cut mould, the TSS102-F can satisfy the needs of customers looking for a fast and functional tabletop semiautomatic machine. The final result is a sealed tray with an excellent aesthetic finish, perfect for supermarket shelves.

◻ Mit ihren geringen Ausmaßen und der personalisierten festen Form mit Ausstanzung erfüllt die TSS102-F alle Anforderungen derer, die eine halbautomatische schnelle und funktionale Tischmaschine suchen. Das Ergebnis ist eine Schale mit einer optimalen ästhetischen Ausführung, die perfekt für die Regale der Supermärkte ist. Die optionale Gasspülung verbessert die Erhaltung der Produktfrische.



Modello	Model	Modell	TSS102-F
Dim. macchina / Peso	Machine sizes / Weight	Größe / Gewicht	295 x 450 h 555 mm / 25 kg
Voltaggio assorbimento	Voltage absorption	Spannung Absorption	230 V - 0,75 kW
Dim. max vaschette	Tray max sizes	Max. Schalengröße	186 x 229 h 135 mm
Dimensione max film	Max reel dimension	Max Foliengröße	L= 215 - Ø 200 mm
Cicli/minuto	Cycles/minute	Zyklen/Minute	3-8

Stampi fustellati

Die-cut moulds

Folienausstanzformen

◊ Optare per uno stampo fustellato o non fustellato ci permette di scegliere tra diverse soluzioni estetiche di finitura della vaschetta. Nel primo caso il film viene tagliato perimetralmente attorno alla sagoma della vaschetta. Questa soluzione garantisce ottimi risultati in termini di rifinitura del prodotto e rappresenta la soluzione ideale per i prodotti destinati agli scaffali dei supermercati. Gli stampi non fustellati si caratterizzano per la maggiore flessibilità e rapidità del cambio di formato, senza però sagomare il film attorno alla vaschetta.

◊ Opting for a die-cut or a no die-cut mould allows us choosing from different aesthetic finishing solutions. In the former case, the film is cut around the perimeter of the tray, following its shape. This solution grants excellent results in terms of product finishing and is ideal for products destined to supermarket shelves. Moulds with no die-cut offer greater flexibility and a faster tool change, though do no shape the film around the tray.

◻ Die Formen mit oder ohne Folienausstanzung erlauben die Auswahl zwischen unterschiedlichen ästhetischen Schalenführungen. Im ersten Fall wird die Folie um den Schalenrand herum geschnitten. Diese Lösung gewährleistet exzellente Ergebnisse hinsichtlich der Produktendfertigung und stellt die ideale Option für die Produkte dar, die in den Regalen der Supermärkte aufgestellt werden. Die Formen ohne Ausstanzung zeichnen sich durch höhere Flexibilität und Schnelligkeit des Werkzeugwechsels aus, ohne jedoch die Folie um die Schale herum zu befestigen.

Termosigillatrici semiautomatica elettrica con fustella

Semi-automatic electrical thermosealing machine with die-cut

Halbautomatische elektrischer Schalensiegler mit Folienausstanzung

▢ Pannello di controllo intuitivo

- ⊗ Intuitive control panel
- ▢ Intuitives Bedienfeld

▢ Microperforatore film (optional)

- ⊗ Film micropuncher (optional)
- ▢ Mikroperforierungseinheit für Folie (Optional)

▢ Recupero sfrido integrato

- ⊗ Integrated scraps recovery
- ▢ Restfolienabwicklung

▢ Lavaggio gas (optional)

- ⊗ Gas flushing (optional)
- ▢ Gasspülung (Optional)

▢ Carrello supporto macchina (optional)

- ⊗ Support trolley (optional)
- ▢ Inox Wagen (Optional)

▢ Segnale acustico e visivo di fine ciclo

- ⊗ End of cycle visual and acoustic signal
- ▢ Zyklus Beendung mit akustischem und optischem Signal

▢ 9 programmi memorizzabili

- ⊗ 9 customizable sealing programs
- ▢ 9 anpassbare Verpackungsprogramme

▢ Ottima finitura estetica della vaschetta

- ⊗ Excellent aesthetic finish
- ▢ Ausgezeichnete ästhetische Ausführung

▢ Guide di scorrimento telescopiche

- ⊗ Telescopic sliding guides
- ▢ Teleskopische Gleitschienen

▢ Stampi fustellati personalizzati

- ⊗ Customised die-cut moduls
- ▢ Personalisierte Folienausstanzformen

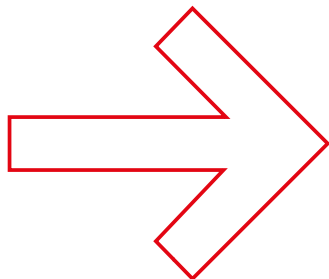

TSS114





△ La termosigillatrice TSS114 è una macchina elettrica da banco. Il recupero sfrido integrato e le guide di scorrimento telescopiche, la rendono particolarmente compatta e facile da installare. La macchina si caratterizza per l'amplia superficie saldante e il taglio del film tutt'attorno al bordo della vaschetta. Il risultato finale è una vaschetta sigillata e con un'ottima finitura estetica, perfetta per gli scaffali dei supermercati. Disponibile come opzione il lavaggio gas.

○ The tray sealer TSS114 is an electrical tabletop machine. The integrated film scraps recovery and the telescopic sliding guides grant compactness and facilitate installation. The tray sealer is equipped with a wide sealing plate with die-cut blades for film cut all around the tray profile. The final result is a tray sealed with a perfect finishing, the ideal solution for supermarkets shelves. Available as option: gas flushing.

□ Der Schalensiegler TSS114 ist eine elektrische Tischmaschine. Die integrierte Restfolienabwicklung und die teleskopischen Gleitschienen machen die Maschine besonders kompakt und einfach zu installieren. Die Maschine zeichnet sich durch die breite Siegelfläche und den Folienschnitt um den Schalenrand aus. Das Ergebnis ist eine versiegelte Schale mit einem ausgezeichneten ästhetischen Finish, perfekt für die Supermarktregale. Eine Version mit Gasspülung ist auch erhältlich.

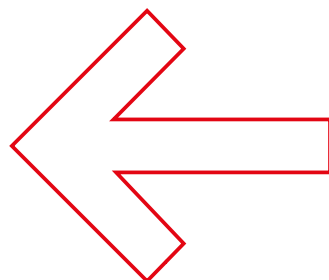

Modello	Model	Modell	TSS114
Dim. macchina / Peso	Machine sizes / Weight	Größe / Gewicht	580 x 560 h 720 mm / 65 kg
Voltaggio assorbimento	Voltage absorption	Spannung Absorption	230 V - 1,5/2 kW
Dim. max vaschette	Tray max sizes	Max. Schalengröße	420 x 280 h 175 mm
Dimensione max film	Max reel dimension	Max Foliengröße	L= 350 - Ø 250 mm
Cicli/minuto	Cycles/minute	Zyklen/Minute	3-6

Termosigillatrice semiautomatica pneumatica con fustella

Semi-automatic pneumatic thermosealing machine with die-cut

Halbautomatischer pneumatischer Schalensiegler mit Folienausstanzung

- ▢ Pannello di controllo intuitivo
- ⊗ Intuitive control panel
- ▢ Intuitives Bedienfeld

- ▢ Microperforatore film (optional)
- ⊗ Film micropuncher (optional)
- ▢ Mikroperforierungseinheit für Folie (Optional)

- ▢ Ottima finitura estetica della vaschetta
- ⊗ Excellent aesthetic finish
- ▢ Ausgezeichnete ästhetische Ausführung

- ▢ Apertura automatica del cassetto (optional)
- ⊗ Automatic opening of the drawer (optional)
- ▢ Automatisches Öffnen der Schublade (optional)

- ▢ Stampi fustellati personalizzati
- ⊗ Customised die-cut moulds
- ▢ Personalisierte Folienausstanzformen



- ▢ Segnale acustico e visivo di fine ciclo
- ⊗ End of cycle visual and acoustic signal
- ▢ Zyklus Beendung mit akustischem und optischem Signal

- ▢ 9 programmi memorizzabili
- ⊗ 9 customizable sealing programs
- ▢ 9 anpassbare Verpackungsprogramme

- ▢ Movimentazione pneumatica
- ⊗ Pneumatic handling
- ▢ Pneumatische Handhabung

- ▢ Lavaggio gas (optional)
- ⊗ Gas flushing (optional)
- ▢ Gasspülung (Optional)

- ▢ Recupero sfrido (optional)
- ⊗ Scraps recovery (optional)
- ▢ Restfolienabwicklung (Optional)

- ▢ Compressore silenzioso 50 L (optional)
- ⊗ Silenced compressor 50 L (optional)
- ▢ Stummgeschalteter Kompressor 50 L (Optional)

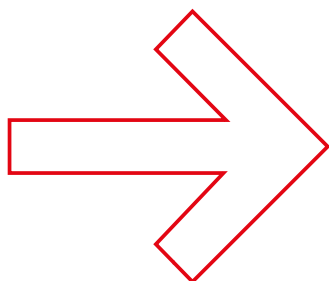

TSS112

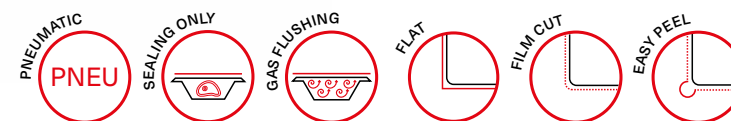

☐ La termosigillatrice pneumatica da banco TSS112 è una macchina compatta dotata di un'ampia superficie saldante e taglio perimetrale del film. Il risultato finale è un packaging dall'ottima finitura estetica, perfetto per gli scaffali dei supermercati. L'opzione del recupero sfrido favorisce l'automatizzazione del processo di sigillatura. Per incrementare la vita del prodotto, è possibile applicare il lavaggio gas.

☉ The pneumatic tabletop thermosealer TSS112 is a compact machine with a wide sealing plate and perimetral film cut. The final result is a tray with an excellent aesthetic finish, perfect for supermarket shelves. The film scraps recovery option helps automatizing the sealing process. Gas flushing application helps to increase the life of the product.

☐ Der pneumatische Tischtischsiegler TSS112 ist eine kompakte Maschine mit einer breiten Siegelfläche, die es ermöglicht, die Folie um den Schalenrand herum zu schneiden. Das Endergebnis ist eine Schale mit einer exzellenten ästhetischen Ausführung, perfekt für Supermarktregale. Die optionale Restfolienabwicklung begünstigt die Automatisierung des Versiegelungsprozesses. Die Gasspüloption erlaubt die Verbesserung der Produktlebensdauer.



Modello	Model	Modell	TSS112
Dim. macchina / Peso	Machine sizes / Weight	Größe / Gewicht	560 x 580 h 510 mm / 65 kg
Voltaggio- assorbimento	Voltage-absorption	Spannung-Absorption	230 V - 1,5/2,5 kW
Consumo aria	Air consumption	Luftverbrauch	2,5 NI/c
Pressione aria	Air pressure	Luftdruck	6 bar
Dim. max vaschette	Tray max sizes	Max. Schalengröße	280 x 420 h 175 mm
Dimensione max film	Max reel dimension	Max Foliengröße	L= 450 (470) - Ø 250 mm
Cicli/minuto	Cycles/minute	Zyklen/Minute	3-8

☐ Lavaggio gas

☉ Gas flushing

☐ Gasspülung

☐ La tecnologia lavaggio gas prevede l'iniezione di gas inerte in vaschetta, durante il ciclo di confezionamento. Questo sistema aiuta ad ottimizzare la vita del prodotto e a prevenirne il deterioramento.

☉ Gas flushing technology involves the injection of inert gas into the tray during the packaging cycle. This system helps to optimize the life of the product and prevents its deterioration.

☐ Die Gasspülung-Technologie sieht die Injektion von Inertgas in die Schale während des Verpackungszyklus vor. Dieses System erlaubt eine verbesserte Konservierung und verlängerte Haltbarkeit der Lebensmittel.



02.

🏠 Termosigillatrici MAP

🕒 MAP thermosealing machines

📦 Schalensiegelgeräte in MAP



🏠 Quando parliamo di confezionamento ATM ci riferiamo ad una tecnologia di confezionamento appositamente pensata per migliorare la conservazione dei prodotti.

Si tratta di un processo che vede l'impiego di miscele di gas alimentari composte da elementi già presenti nell'aria quali Azoto (N₂), Anidride Carbonica (CO₂), e Ossigeno (O₂).

Oltre ad allungare la vita del prodotto, la tecnologia ATM permette di mantenere le proprietà dei prodotti e riduce la crescita microbica.

🕒 When we talk about MAP packaging, we refer to a packaging process specifically designed to improve the storage of products. It is a process that requires the use of specific mixtures of gases found in the air, namely Nitrogen (N₂), Carbon Dioxide (CO₂), and Oxygen (O₂). In addition to extending a product's shelf life, MAP technology allows preserving food prop-

erties and reducing microbial growth.

📦 Wenn über MAP-Verpackung gesprochen wird, bezieht sich man auf eine Technologie, die besonders dafür entwickelt wurde, die Produkterhaltung zu verbessern.

Es geht um einen Prozess, bei dem die Luft in einer Verpackung durch Nahrungsmittelgasmischungen ersetzt wird, wie Stickstoff (N₂), Kohlensäure (CO₂) und Sauerstoff (O₂).

Die MAP-Technologie verlängert die Lebensdauer der Produkte, lässt die Eigenschaften unverändert und verringert das mikrobielle Wachstum.

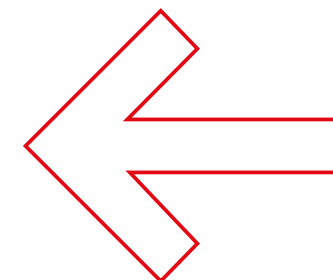

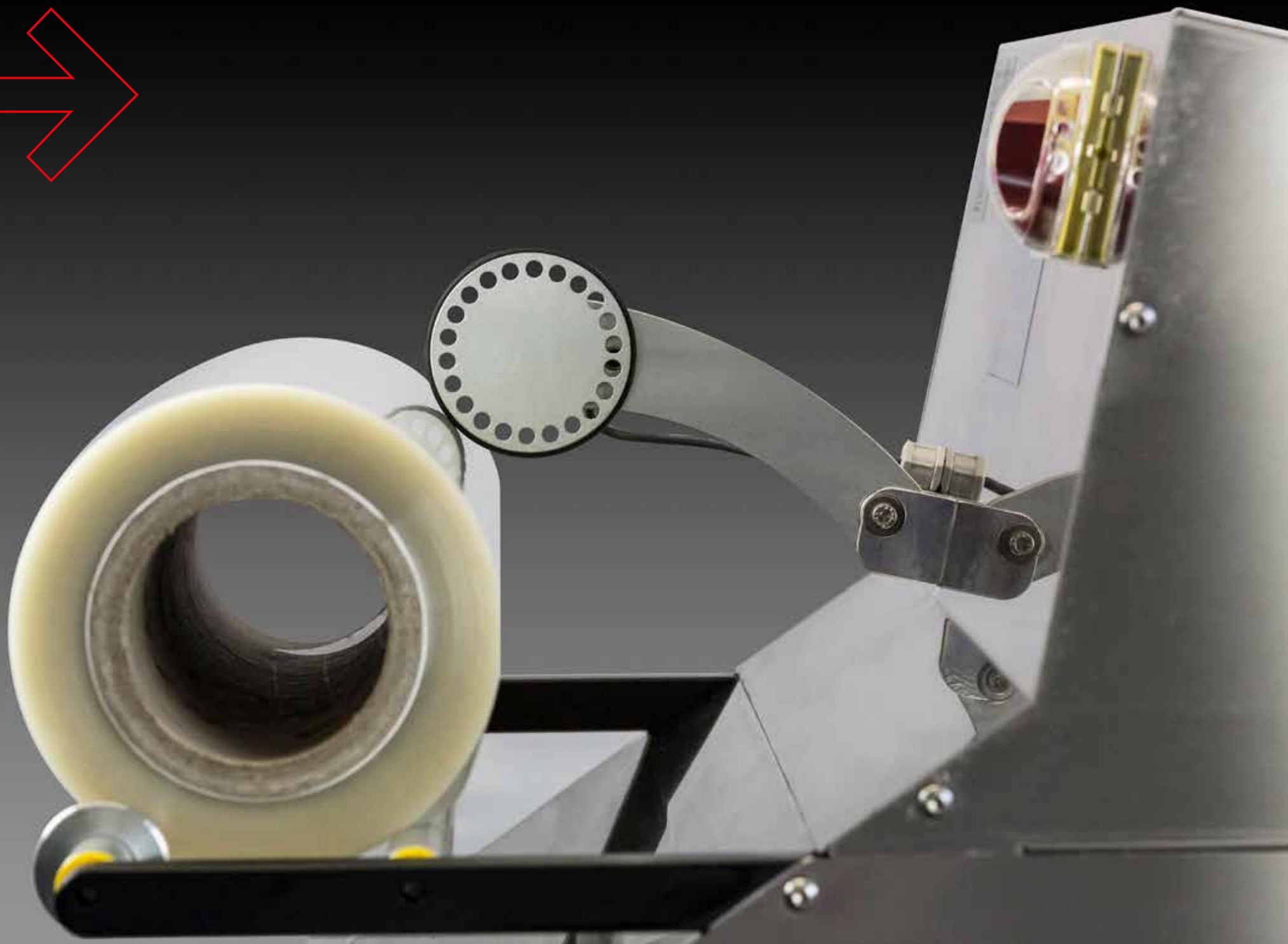

🏠 **Brevetto di movimentazione elettrica**

⊗ **Patented electrical handling system**

☐ **Patentiertes elektrisches Antriebssystem**

🏠 J Pack investe ogni anno risorse in ricerca e sviluppo. Questo impegno ha reso possibile ideare una linea di sigillatrici dotate di un sistema di movimentazione della campana totalmente elettrico. Grazie a questo innovativo sistema è possibile sigillare in atmosfera protettiva, senza dover ricorrere all'aria compressa. Si tratta di una scelta rispettosa dell'ambiente e che permette un risparmio concreto in termini di manutenzione.

⊗ Every year, J Pack invests resources in research and development. This commitment has made possible to design a line of sealers fitted with a fully electric chamber handling system. Thanks to this innovative system it is possible to seal in a modified atmosphere without using compressed air. This is an environmentally friendly choice that allows concrete savings when it comes to maintenance.

☐ J Pack investiert jedes Jahr viele Ressourcen in Forschung und Entwicklung. Dadurch konnte eine Schalsieglerlinie entworfen werden, die mit einem völlig elektrischen Kammerbetriebssystem ausgestattet ist.

Dank diesem innovativen System ist die MAP-Verpackung ohne Anwendung von Druckluft möglich.

Es handelt sich um eine umweltfreundliche Wahl, die eine konkrete Einsparung hinsichtlich der Instandhaltung erlaubt.



Termosigillatrice elettrica semiautomatica MAP

Semi-automatic electric thermosealing machine MAP

Halbautomatischer elektrischer Schalensiegler MAP

- ▢ 10 programmi memorizzabili
- ⊗ 10 customizable sealing programs
- ▢ 10 anpassbare Verpackungsprogramme

- ▢ Opzioni di sigillatura: solo saldatura, vuoto, MAP
- ⊗ Sealing Options: sealing only, vacuum, MAP
- ▢ Versiegelungsweisen: nur Versiegelung, Vakuum, MAP

- ▢ Pannello di controllo intuitivo
- ⊗ Intuitive control panel
- ▢ Intuitives Bedienfeld

- ▢ Industria 4.0 (optional)
- ⊗ Integration with PC-controlled interface (optional)
- ▢ Vernetzung mit PC-gesteuerter Interface (Optional)

- ▢ Ampia superficie saldante
- ⊗ Wide sealing plate
- ▢ Breite Siegelfläche

- ▢ Soft Vacuum (optional)
- ⊗ Soft Vacuum (optional)
- ▢ Soft Vacuum (Optional)

- ▢ Cutter frontale taglio film (optional)
- ⊗ Frontal cutter for Film (optional)
- ▢ Frontales Trennmesser für Folien (Optional)

- ▢ Movimentazione elettrica brevettata
- ⊗ Patented electric handling system
- ▢ Patentiertes elektrisches Antriebssystem

- ▢ Cambio stampo rapido senza attrezzi
- ⊗ Fast mould change without tools
- ▢ Schneller Werkzeugwechsel ohne Geräte

- ▢ Pompa per il vuoto integrata da 12 m³/h (25 m³/h optional)
- ⊗ Integrated 12 m³/h vacuum pump (25 m³/h optional)
- ▢ Integrierte 12 m³/h Vakuumpumpe (25 m³/h Optional)

- ▢ Stampi personalizzati su misura
- ⊗ Customised moulds
- ▢ Personalisierte Formen

- ▢ Filtri pompa liquidi e polveri (optional)
- ⊗ Vacuum pump filters dust, liquids (optional)
- ▢ Staub- und Flüssigkeitsfilter für die Pumpe (Optional)

- ▢ Pompa uso ossigeno (optional)
- ⊗ Pump suitable for oxygen (optional)
- ▢ Pumpe geeignet für Oxygen (Optional)

- ▢ Carrello supporto macchina con pompa integrata (optional)
- ⊗ Support trolley with integrated vacuum pump (optional)
- ▢ Inox Wagen mit integrierter Vakuumpumpe (Optional)

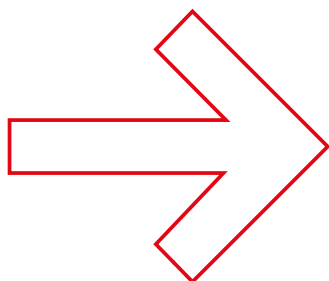

TSS115-BG

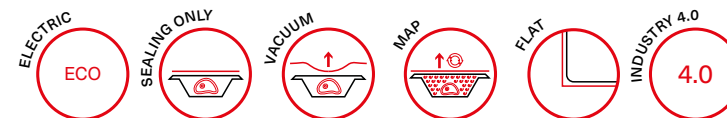



△ La TSS115-BG è una termosigillatrice da banco dalle dimensioni compatte. Grazie al sistema di movimentazione elettrico brevettato, l'operatore non ha bisogno di compressore. La pompa vuoto integrata sul retro della macchina ne semplifica l'installazione. L'ampia superficie saldante permette di sigillare vaschette fino a ½ GN.

⊙ The TSS115-BG is a compact tabletop thermosealing machine. Thanks to the patented electric handling system, the operator does not require a compressor. The vacuum pump integrated in the back simplifies its installation. The wide sealing plate allows to seal trays up to ½ GN.

□ Die TSS115-BG ist eine Tischmaschine mit kompakter Größe. Dank dem patentierten elektrischen Antriebssystem ist kein Kompressor erforderlich. Die Vakuumpumpe ist auf der Rückseite der Maschine integriert, wodurch die Installation erleichtert wird. Die breite Siegelfläche ermöglicht die Versiegelung von Schalen bis zu 1/2 GN.



Modello	Model	Modell	TSS115-BG
Dim. macchina / Peso	Machine sizes / Weight	Größe / Gewicht	500 x 680 (780) h 780 mm / 75 kg
Voltaggio assorbimento	Voltage absorption	Spannung Absorption	230 V - 1,5 kW
Alimentazione gas	Gas feeding	Gasversorgung	3 bar
Dim. max vaschette	Tray max sizes	Max. Schalengröße	260 x 370 h 100 mm
Dimensione max film	Max reel dimension	Max Foliengröße	L= 380 - Ø 200 mm
Cicli/minuto	Cycles/minute	Zyklen/Minute	3-8

Termostigillatrice elettrica semiautomatica MAP

Semi-automatic electric thermosealing machine MAP

Halbautomatischer elektrischer Schalensiegler MAP

- ▢ 10 programmi memorizzabili
- ⊗ 10 customizable sealing programs
- ▢ 10 anpassbare Verpackungsprogramme

- ▢ **Molteplici opzioni di sigillatura: solo saldatura, vuoto, MAP**
- ⊗ **Sealing Options: sealing only, vacuum, MAP**
- ▢ **Versiegelungsweisen: nur Versiegelung, Vakuum, MAP**

- ▢ **Pannello di controllo intuitivo**
- ⊗ Intuitive control panel
- ▢ Intuitives Bedienfeld

- ▢ **Industria 4.0 (optional)**
- ⊗ Integration with PC-controlled interface (optional)
- ▢ Vernetzung mit PC-gesteuerter Interface (Optional)

- ▢ **Sensore film stampato (optional)**
- ⊗ Photocell for printed film (optional)
- ▢ Fotozelle für bedruckte Folien (Optional)

- ▢ **Soft Vacuum (optional)**
- ⊗ Soft Vacuum (optional)
- ▢ Soft Vacuum (Optional)

- ▢ **Movimentazione elettrica brevettata**
- ⊗ Patented electric handling system
- ▢ Patentiertes elektrisches Antriebssystem

- ▢ **Recupero sfrido (optional)**
- ⊗ Scraps recovery (optional)
- ▢ Restfolienabwicklung (Optional)

- ▢ **Easy peel (optional)**
- ⊗ Easy peel corner (optional)
- ▢ Easypeel Ecke (Optional)

- ▢ **Pompa per il vuoto integrata da 25 m³/h (40/70 m³/h optional)**
- ⊗ Integrated 25 m³/h vacuum pump (40/70 m³/h optional)
- ▢ Integrierte 12 m³/h Vakuumpumpe (40/70 m³/h Optional)

- ▢ **Ottima finitura estetica della vaschetta**
- ⊗ Excellent aesthetic finish
- ▢ Ausgezeichnete ästhetische Ausführung

- ▢ **Filtri pompa liquidi e polveri (optional)**
- ⊗ Vacuum pump filters dust, liquids (optional)
- ▢ Staub- und Flüssigkeitsfilter für die Pumpe (Optional)

- ▢ **Stampi fustellati personalizzati**
- ⊗ Customised die-cut moulds
- ▢ Personalisierte Folienausstanzformen

- ▢ **Pompa uso ossigeno (optional)**
- ⊗ Pump suitable for oxygen (optional)
- ▢ Pumpe geeignet für Oxygen (Optional)

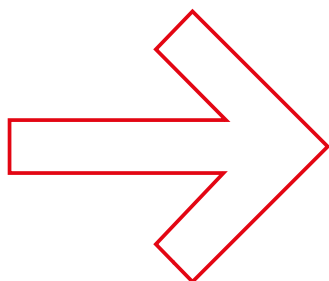

TSS125-BG

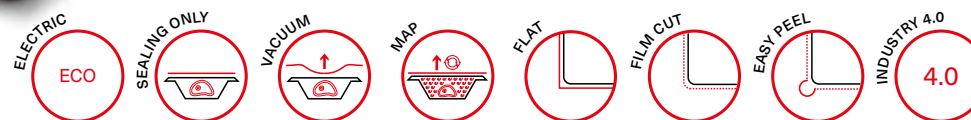

☐ Dotata del sistema di movimentazione elettrico brevettato J Pack, la termosigillatrice carrellata TSS125-BG permette il confezionamento MAP senza dover ricorrere all'aria compressa. Gli stampi fustellati, possono essere personalizzati in funzione della dimensione e forma della vaschetta.

⊗ Equipped with our patented electric handling system, the trolley-mounted thermosealing machine TSS125-BG allows MAP packaging without using compressed air. The die-cut moulds can be customized according to the size and shape of the tray.

☐ Die Thermoschweißmaschine mit Wagen TSS125-BG ist mit einem patentierten elektrischen Antriebssystem ausgestattet und erlaubt die MAP-Versiegelung ohne Anwendung von Druckluft. Die Formen mit Folienausstanzung können je nach Größe und Gestalt der Schalen personalisiert werden.



Modello	Model	Modell	TSS125-BG
Dim. macchina / Peso	Machine sizes / Weight	Größe / Gewicht	595 x 750 (970) h 1490 mm / 170 kg
Voltaggio assorbimento	Voltage absorption	Spannung Absorption	230 V – 3,5 kW
Alimentazione gas	Gas feeding	Gasversorgung	3 bar
Dim. max vaschette	Tray max sizes	Max. Schalengröße	280 x 420 h 100 mm (Optional 150)
Dimensione max film	Max reel dimension	Max Foliengröße	L= 450 (470) - Ø 250 mm
Cicli/minuto	Cycles/minute	Zyklen/Minute	3-8

- ☐ **Soft vacuum**
- ⊗ **Soft vacuum**
- ☐ **Soft Vacuum**

☐ L'opzione soft vacuum permette di eseguire durante il ciclo MAP, il vuoto ad intermittenza. Durante questo processo, la macchina alterna fasi di aspirazione con sequenze di arresto, fino al raggiungimento della percentuale di vuoto definita. È pensata per il confezionamento di prodotti liquidi e cremosi garantendone la stabilità.

⊗ The soft vacuum option performs intermittent vacuum during the MAP cycle. During this process, the machine alternates suction phases with stop sequences, until the defined vacuum percentage is reached. It is designed for the packaging of liquid and creamy products, guaranteeing their stability.

☐ Die Soft Vacuum Option ermöglicht eine schrittweise Durchführung des Vakuumprozesses während des MAP-Versiegelungszyklus. Während dieses Verfahrens führt die Maschine abwechselnd Absaug- und Abschaltphasen bis zum Erreichen des festgelegten Vakuumprozentsatzes durch. Diese Lösung wurde für Flüssigkeiten und cremige Produkte entwickelt, um ihre Stabilisierung zu gewährleisten.

Termosigillatrice pneumatica semiautomatica MAP

Semi-automatic pneumatic thermosealing machine MAP

Halbautomatischer pneumatischer Schalensiegler MAP

- ▢ 10 programmi memorizzabili
- ⊗ 10 customizable sealing programs
- ▢ 10 anpassbare Verpackungsprogramme

- ▢ Pannello di controllo intuitivo
- ⊗ Intuitive control panel
- ▢ Intuitives Bedienfeld

- ▢ Sensore film stampato (optional)
- ⊗ Photocell for printed film (optional)
- ▢ Fotozelle für bedruckte Folien (Optional)

- ▢ Movimentazione pneumatica
- ⊗ Pneumatic handling
- ▢ Pneumatische Handhabung

- ▢ Apertura automatica del cassetto (optional)
- ⊗ Automatic opening of the drawer (optional)
- ▢ Automatisches Öffnen der Schublade (optional)

- ▢ Easy peel (optional)
- ⊗ Easy peel corner (optional)
- ▢ Easypeel Ecke (Optional)

- ▢ Ottima finitura estetica della vaschetta
- ⊗ Excellent aesthetic finish
- ▢ Ausgezeichnete ästhetische Ausführung

- ▢ Stampi fustellati personalizzati
- ⊗ Customised die-cut moulds
- ▢ Personalisierte Folienausstanzformen

- ▢ Opzioni di sigillatura: solo saldatura, vuoto, MAP
- ⊗ Sealing Options: sealing only, vacuum, MAP

- ▢ Versiegelungsweisen: nur Versiegelung, Vakuum, MAP

- ▢ Industria 4.0 (optional)
- ⊗ Integration with PC-controlled interface (optional)
- ▢ Vernetzung mit PC-gesteuerter Interface (Optional)

- ▢ Soft Vacuum (optional)
- ⊗ Soft Vacuum (optional)
- ▢ Soft Vacuum (Optional)

- ▢ Recupero sfrido (optional)
- ⊗ Scraps recovery (optional)
- ▢ Restfolienabwicklung (Optional)

- ▢ Pompa per il vuoto integrata da 25 m³/h (40/70 m³/h optional)
- ⊗ Integrated 25 m³/h vacuum pump (40/70 m³/h optional)
- ▢ Integrierte 12 m³/h Vakuumpumpe (40/70 m³/h Optional)

- ▢ Compressore integrato (optional)
- ⊗ Integrated compressor (optional)
- ▢ Integrierter Kompressor (Optional)

- ▢ Filtri pompa liquidi e polveri (optional)
- ⊗ Vacuum pump filters dust, liquids (optional)
- ▢ Staub- und Flüssigkeitsfilter für die Pumpe (Optional)

- ▢ Pompa uso ossigeno (optional)
- ⊗ Pump suitable for oxygen (optional)
- ▢ Pumpe geeignet für Oxygen (Optional)

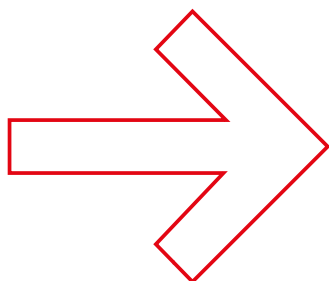

TSS125

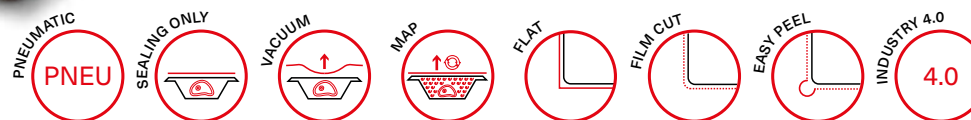

△ La termosigillatrice semi-automatica pneumatica TSS125 è una macchina carrellata ideata per il confezionamento MAP. Grazie allo stampo fustellato, il risultato finale è una vaschetta perfetta per gli scaffali dei supermercati per un prodotto sempre fresco e invitante.

⊖ The semi-automatic pneumatic sealer TSS125 is a trolley-mounted machine designed for MAP packaging. Thanks to the die-cut moulds, the final result is a tray perfect for supermarket shelves, for an always fresh and inviting product.

□ Die halbautomatische pneumatische Thermoschweißmaschine mit Wagen TSS125 ist ideal für die MAP-Verpackung. Dank der Form mit Folienausstanzung ist das Endergebnis eine Schale mit immer frischen und einladenden Lebensmitteln, die perfekt in die Regale im Supermarkt passt.



Modello	Model	Modell	TSS125
Dim. macchina / Peso	Machine sizes / Weight	Größe / Gewicht	595 x 750 (970) h 1490 mm / 170 kg
Voltaggio-assorbimento	Voltage-absorption	Spannung-Absorption	230 V - 2,5 / 3,5 kW
Consumo aria	Air consumption	Luftverbrauch	7 NI/c
Pressione aria	Air pressure	Luftdruck	6-8 bar
Alimentazione gas	Gas feeding	Gasversorgung	3 bar
Dim. max vaschette	Tray max sizes	Max. Schalengröße	280 x 420 h 100 mm (Optional 150)
Dimensione max film	Max reel dimension	Max Foliengröße	L= 450 (470) - Ø 250 mm
Cicli/minuto	Cycles/minute	Zyklen/Minute	3-8

🏠 **Industria 4.0**

🕒 **4.0 industry**

📊 **Industrie 4.0**



⊖ L'opzione INDUSTRIA 4.0, disponibile per i modelli MAP/SKIN, consente di trasmettere e scaricare, tramite cavo ethernet, le informazioni di confezionamento dalla termosigillatrice al PC ed elaborarle con un programma di analisi dei dati, come Microsoft Excel.

⊖ The 4.0 INDUSTRY option, available for the MAP/SKIN models, allows to send and download, through an ethernet cable, all the packaging information from the thermosealing machine to the PC. Records can be elaborated with a data analysis software such as Microsoft Excel.

□ Die Option INDUSTRIE 4.0 (Vernetzung mit PC-gesteuerter Interface) ist für die Modelle MAP und SKIN verfügbar und ermöglicht die Übermittlung und das Herunterladen von Verpackungsdaten auf einen Computer, um die Informationen mit einem Datenanalyseprogramm (wie Microsoft Excel) zu bearbeiten.



TSS125-BG-XL

🏠 La TSS125-BG-XL è dotata di una piastra saldante oversize, perfetta per la sigilatura di grandi formati. È la soluzione ideale per il packaging di pizza e focacce.

🕒 The TSS125-BG-XL is an electric model with an oversize sealing plate perfect for the sealing of large formats. It is the ideal solution for pizza and quiches.

📦 Die TSS125-BG-XL verfügt über eine Oversize-Siegelplatte, die perfekt zum Versiegeln der großformatigen Schalen ist. Diese Maschine stellt die ideale Option für die Verpackung von Pizza, Focaccia und Quiches dar.

Dim. macchina / Peso	Machine sizes / Weight	Größe / Gewicht	680 x 970 h 1495 mm / 170 kg
Dimensione max vaschette	Tray max sizes	Max Schalengröße	330 x 420 h 100 mm (Optional 150)



TSS125-XH

🏠 La TSS125-XH, con camera vuoto maggiorata, è stata concepita per il confezionamento di secchi e bicchieri con profondità fino a 250 mm.

🕒 The thermosealing machine TSS125-XH has an increased vacuum chamber and it has been conceived for the sealing of buckets and cups up to 250 mm.

📦 Die TSS125-XH ist mit einer erhöhten Vakuumkammer ausgestattet. Sie wurde entworfen, um Eimer und Gläser mit einer Tiefe bis zu 250 mm zu verpacken.

Dim. macchina / Peso	Machine sizes / Weight	Größe / Gewicht	595 x 750 h 1595 mm / 170 kg
Dimensione max vaschette	Tray max sizes	Max Schalengröße	280 x 420 h 250 mm

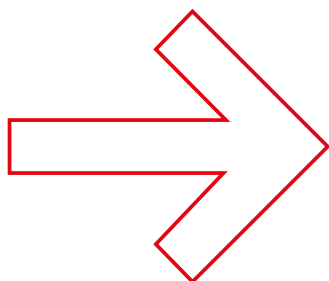

🏠 **Brevetto Autospeed**

⊗ **Autospeed Patent**

☐ **Autospeed Patent**

⊗ L'innovativo brevetto AutoSpeed (N 3456) è stato progettato e realizzato da J Pack con l'obiettivo di rendere l'operazione di confezionamento totalmente automatizzata e performante. Il dispositivo J Pack di caricamento, traslazione ed espulsione delle vaschette, prevede un sistema di fotocellule che lavorano in combinazione con una navetta di carico, permettendo di trasportare automaticamente la vaschetta durante il ciclo. Selezionando il ciclo automatico si ha la possibilità di lavorare in continuo attraverso un sensore di presenza della vaschetta in carico, che permette l'alimentazione continuativa e rende la macchina veloce, costante e particolarmente produttiva.

⊗ The innovative AutoSpeed patent (N 3456) has been designed and manufactured in order to make sealing operations totally automated and performing. The J Pack device for loading, translating and ejecting trays consists of a system of photocells that work in combination with the loading shuttle; it automatically transports the tray during the cycle. By selecting the automatic cycle, it is possible to work continuously through a sensor that detects the presence of trays, and which allows continuous feeding. This speeds up the machine operation making the packaging process faster and constant.

☐ Das innovative von J Pack entwickelte Patent AutoSpeed (N 3456) wird mit dem Ziel hergestellt, den Verpackungsprozess völlig automatisch und zuverlässig zu machen. Das J Pack-System für die Ladung, Beförderung und den Auswurf der Schalen umfasst ein System von Photozellen, das in Verbindung mit einer Ladevorrichtung arbeitet. Dadurch werden die Schalen während des Zyklus automatisch befördert. Durch die Auswahl des automatischen Zyklus kann mithilfe eines Schalenanwesenheitssensors kontinuierlich gearbeitet werden, wodurch eine Dauerzufuhr möglich ist und die Maschine schneller, konstanter und besonders produktiv wird.



Termosigillatrice pneumatica automatica MAP

Automatic pneumatic thermosealing machine MAP

Automatischer pneumatischer Schalensiegler MAP

- ▢ Stampante Ink-jet (optional)
- ⊗ Ink-jet printer (optional)
- ▢ Ink-jet Drucker (Optional)

- ▢ Pannello di controllo intuitivo
- ⊗ Intuitive control panel
- ▢ Intuitives Bedienfeld

- ▢ Lettore tacca per centratura film (optional)
- ⊗ Photocell for printed film (optional)
- ▢ Fotozelle für bedruckte Folien (Optional)

- ▢ Molteplici opzioni di sigillatura: solo sigillatura, vuoto, MAP
- ⊗ Sealing Options: sealing only, vacuum, MAP
- ▢ Versiegelungsweisen: nur Versiegelung, Vakuum, MAP

- ▢ Possibilità di dialogo con altri dispositivi
- ⊗ Possibility of dealing with other devices
- ▢ Mögliche Integration mit anderen Geräten

- ▢ Industria 4.0 (optional)
- ⊗ Integration with PC-controlled interface (optional)
- ▢ Vernetzung mit PC-gesteuerter Interface (Optional)

- ▢ Velocità di avanzamento della navetta regolabile
- ⊗ Shuttle speed regulators
- ▢ Einstellbare Fördergeschwindigkeit der Ladevorrichtung

- ▢ Soft Vacuum (optional)
- ⊗ Soft Vacuum (optional)
- ▢ Soft Vacuum (Optional)

- ▢ Pompa per il vuoto integrata da 40 m³/h (70 m³/h optional)
- ⊗ Integrated 12 m³/h vacuum pump 40 m³/h (70 m³/h optional)
- ▢ Integrierte 12 m³/h Vakuumpumpe 40 m³/h (70 m³/h Optional)

- ▢ Stampi fustellati personalizzati
- ⊗ Customised die-cut moulds
- ▢ Personalisierte Folienausstanzformen

- ▢ Filtri pompa liquidi e polveri (optional)
- ⊗ Vacuum pump filters dust, liquids (optional)
- ▢ Staub- und Flüssigkeitsfilter für die Pumpe (Optional)

- ▢ Carrello portastampi (optional: cambio stampo facilitato)
- ⊗ Mould storage trolley (optional: eased mould change)
- ▢ Formenhalterwagen (Optional: erleichterter Werkzeugswechsel)

- ▢ Pompa uso ossigeno
- ⊗ Pump suitable for oxygen (optional)
- ▢ Pumpe geeignet für Oxygen (Optional)

- ▢ Movimentazione pneumatica
- ⊗ Pneumatic handling
- ▢ Pneumatische Handhabung

- ▢ Compressore silenzioso (non integrato)
- ⊗ Silenced air compressor (not Integrated)
- ▢ Stummgeschalteter Kompressor (nicht integriert)

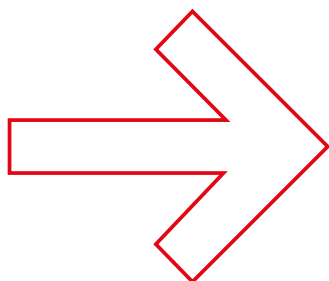
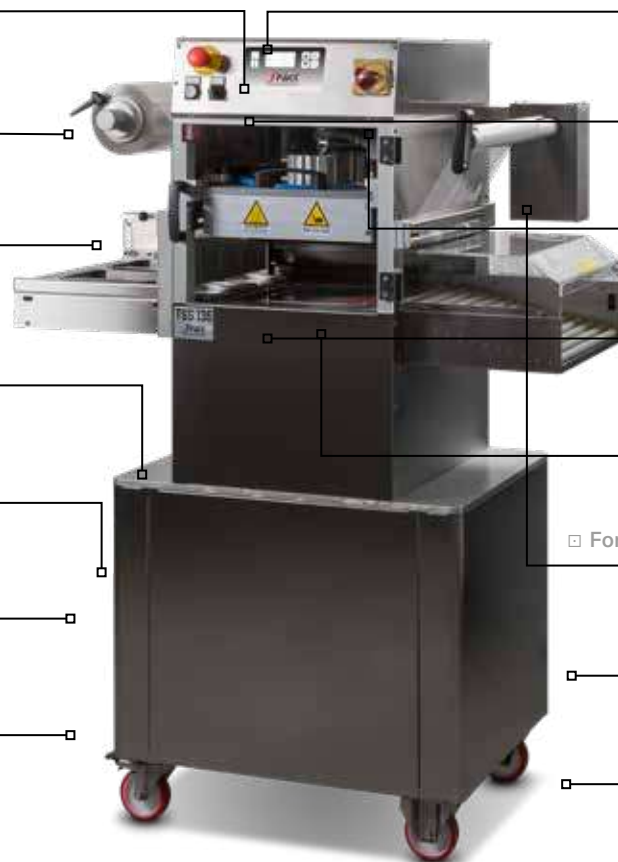

TSS136

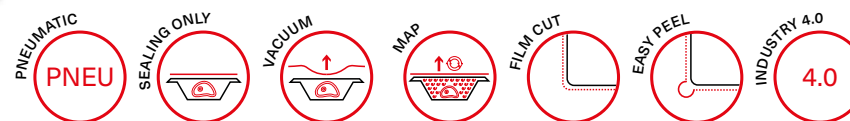



△ La sigillatrice automatica TSS136 è stata concepita per il confezionamento in linea di laboratori, supermercati e centri cottura con una produttività medio-alta. La macchina è dotata del sistema di movimentazione brevettato AutoSpeed e si caratterizza per le dimensioni ultra compatte.

⊙ The automatic thermosealing machine TSS136 has been conceived for the in-line packaging for laboratories, supermarkets, collective restoration with a high-medium productivity. The machine is equipped with the AutoSpeed patented handling system and it is distinguished by the ultra-compact sizes.

⊠ Der automatische Schalensiegler TSS136 wurde für die In-line Verpackung in Laboren, Supermärkten und Kochzentren mit mittlerer bis hoher Produktivität entworfen. Die Maschine ist mit unserem patentierten Antriebssystem AutoSpeed ausgestattet und zeichnet sich durch ultra-kompakte Abmessungen aus.

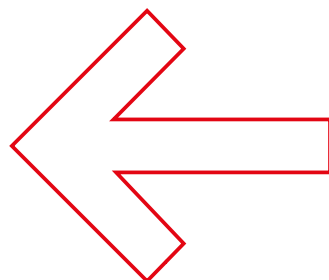

Modello	Model	Modell	TSS136
Dim. macchina / Peso	Machine sizes / Weight	Größe / Gewicht	1130 x 760 h 1540 mm / 270 kg
Voltaggio- assorbimento	Voltage-absorption	Spannung-Absorption	380 V - 2,5/3,5 kW
Consumo aria	Air consumption	Luftverbrauch	24 NI/c
Pressione aria	Air pressure	Luftdruck	6-8 bar
Alimentazione gas	Gas feeding	Gasversorgung	3 bar
Dim. max vaschette	Tray max sizes	Max. Schalengröße	280 x 390 h 100 mm
Dimensione max film (con recupero sfrido)	Max reel dimension (with scraps recovery)	Max Foliengröße (mit Folienausstanzung)	L= 450 - Ø 200 mm
Cicli/minuto	Cycles/minute	Zyklen/Minute	3-8



Termosigillatrice pneumatica automatica MAP

Automatic pneumatic thermosealing machine MAP

Automatischer pneumatischer Schalensiegler MAP

- ▢ Stampante Ink-jet (optional)
- ⊗ Ink-jet printer (optional)
- ▢ Ink-jet Drucker (Optional)

- ▢ Lettore tacca per centratura film (optional)
- ⊗ Photocell for printed film (optional)
- ▢ Fotozelle für bedruckte Folien (Optional)

- ▢ Tre posizioni di carico (optional)
- ⊗ Three loading positions (optional)
- ▢ Drei Ladepositionen (Optional)

- ▢ Possibilità di dialogo con altri dispositivi
- ⊗ Possibility of dealing with other devices
- ▢ Mögliche Integration mit anderen Geräten

- ▢ Pompa per il vuoto integrata da 63 m³/h (100 m³/h optional)
- ⊗ Integrated 63 m³/h vacuum pump (100 m³/h optional)
- ▢ Integrierte 63 m³/h Vakuumpumpe (100 m³/h Optional)

- ▢ Filtri pompa liquidi e polveri (optional)
- ⊗ Vacuum pump filters dust, liquids (optional)
- ▢ Staub- und Flüssigkeitsfilter für die Pumpe (Optional)

- ▢ Opzioni di sigillatura: solo saldatura, vuoto, MAP
- ⊗ Sealing Options: sealing only, vacuum, MAP
- ▢ Versiegelungsweisen: nur Versiegelung, Vakuum, MAP

- ▢ Pannello di controllo touchscreen
- ⊗ Control panel with touchscreen
- ▢ Bedienfeld mit Touchscreen

- ▢ Stampi fustellati personalizzati
- ⊗ Customised die-cut moulds
- ▢ Personalisierte Folienausstanzformen

- ▢ Ottima finitura estetica della vaschetta
- ⊗ Excellent aesthetic finish
- ▢ Ausgezeichnete ästhetische Ausführung

- ▢ Carrello portastampi (optional: cambio stampo facilitato)
- ⊗ Mould storage trolley (optional: eased mould change)
- ▢ Formenhalterwagen (optional: erleichtertes Werkzeugwechsel)

- ▢ Allineatore vaschette in uscita (optional)
- ⊗ Outfeeding trays aligner (optional)
- ▢ Abführausrichtvorrichtung für Schalen (Optional)

- ▢ Nastro motorizzato in uscita (optional)
- ⊗ Motorized outfeeding belt (optional)
- ▢ Motorisiertes Abführband (Optional)

- ▢ Serbatoio d'accumulo gas (optional)
- ⊗ Gas tank (optional)
- ▢ Gastank (Optional)

- ▢ Movimentazione pneumatica
- ⊗ Pneumatic handling
- ▢ Pneumatische Handhabung

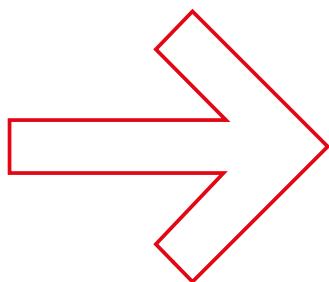

TSS145

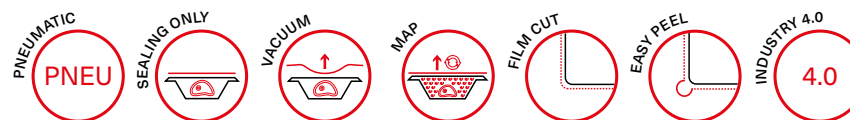



△ La TSS145 è una termosigillatrice automatica per il confezionamento in linea che dispone di tre posizioni di carico e motore brushless. Lo schermo touchscreen si caratterizza per un'interfaccia pratica ed intuitiva pensata per semplificare e velocizzare le operazioni di sigillatura e garantire la massima freschezza del prodotto.

⊙ The TSS145 is an automatic thermosealing machine for in-line production. It has three loading positions and a brushless motor. The touchscreen panel has an intuitive control interface conceived to simplify and speed the packaging operations, granting maximum product freshness.

□ Die TSS145 ist eine automatische Siegelmaschine für die In-line Verpackung und verfügt über drei Ladepositionen und einen Brushless Motor. Der Touchscreen-Schirm ist durch ein praktisches und intuitives Interface charakterisiert, das die Verpackungsoperationen erleichtert und beschleunigt und das für die maximale Produktfrische sorgt.



Modello	Model	Modell	TSS145
Dim. macchina / Peso	Machine sizes / Weight	Größe / Gewicht	3200 x 877 h 1535 mm / 300 kg
Voltaggio-assorbimento	Voltage-absorption	Spannung-Absorption	380 V - 4,7 kW
Consumo aria	Air consumption	Luftverbrauch	30 NI/c
Pressione aria	Air pressure	Luftdruck	6-8 bar
Alimentazione gas	Gas feeding	Gasversorgung	3 bar
Dim. max vaschette	Tray max sizes	Max. Schalengröße	280 x 390 h 100 mm (min 15)
Dimensione max film (con recupero sfrido)	Max reel dimension (with scraps recovery)	Max Foliengröße (mit Folienausstanzung)	L= 480 - Ø 240 mm
Cicli/minuto	Cycles/minute	Zyklen/Minute	3-8



03.

🏠 Termosigillatrici SKIN

🕒 SKIN thermosealing machines

📦 Schalensiegelgeräte in SKIN



🏠 Lo SKIN nasce per rispondere ai bisogni del settore alimentare in continua evoluzione.

Abbinando la tecnologia sottovuoto alla praticità del confezionamento in vaschetta, il risultato è un packaging dal forte impatto estetico che conferisce una seconda pelle protettiva al prodotto.

Guidati dal nostro know-how, abbiamo sviluppato una linea di termosigillatrici, appositamente

te pensata per soddisfare le esigenze della piccola e media produzione, capaci di combinare innovazione e tecnologia alimentare.

🕒 SKIN has been conceived for answering the constantly evolving needs of the food sector. The combination between vacuum technology and the tray packing functionality leads to a

packaging with a strong aesthetic impact that gives a second skin to the product.

Leaded by our know-how we developed a range of tray sealers especially conceived for satisfying the needs of small and medium industry that combines innovation and food technology.

📦 Das SKIN-Verpacken wurde entwickelt, um die in ständiger Entwicklung Bedürfnisse des Verpackungsbereichs zu erfüllen. Dank der Kombination aus Vakuum-Technologie und der Funktionalität des Schalenverpacken ist das Ergebnis eine Verpackung mit einer ausgezeichneten ästhetischen Ausführung, die den Produkten eine zweite schützende Haut verleiht. Gestützt durch unser Know-how haben wir eine Siegelmaschinenlinie entworfen, die speziell auf die Bedürfnisse der kleinen und mittleren Produktion zugeschnitten sind und die Innovation und Lebensmitteltechnologie kombinieren können.



Termostigillatrice pneumatica semiautomatica OVERSKIN

Semiautomatic pneumatic thermosealing machine OVERSKIN

Halbautomatischer pneumatischer Schalensiegler OVERSKIN

- ▢ **Industria 4.0 (optional)**
- ⊗ **Integration with PC-controlled interface (optional)**
- ▢ **Vernetzung mit PC-gesteuerter Interface (Optional)**

- ▢ **10 programmi memorizzabili**
- ⊗ **10 customizable sealing programs**
- ▢ **10 anpassbare Verpackungsprogramme**

- ▢ **Pannello di controllo intuitivo**
- ⊗ **Intuitive control panel**
- ▢ **Intuitives Bedienfeld**

- ▢ **Sensore film stampato (optional)**
- ⊗ **Photocell for printed film (optional)**
- ▢ **Fotozelle für bedruckte Folien (Optional)**

- ▢ **Apertura automatica del cassetto (optional)**
- ⊗ **Automatic opening of the drawer (optional)**
- ▢ **Automatisches Öffnen der Schublade (optional)**

- ▢ **Easy peel (optional)**
- ⊗ **Easy peel corner (optional)**
- ▢ **Easypeel Ecke (Optional)**

- ▢ **Ottima finitura estetica della vaschetta**
- ⊗ **Excellent aesthetic finish**
- ▢ **Ausgezeichnete ästhetische Ausführung**

- ▢ **Stampi fustellati personalizzati**
- ⊗ **Customised die-cut moulds**
- ▢ **Personalisierte Folienausstanzformen**

- ▢ **Soft Vacuum (optional)**
- ⊗ **Soft Vacuum (optional)**
- ▢ **Soft Vacuum (Optional)**

- ▢ **Recupero sfrido (optional)**
- ⊗ **Scraps recovery (optional)**
- ▢ **Restfolienabwicklung (Optional)**

- ▢ **Movimentazione pneumatica**
- ⊗ **Pneumatic handling**
- ▢ **Pneumatische Handhabung**

- ▢ **Compressore silenzioso esterno (optional)**
- ⊗ **External silenced compressor (optional)**
- ▢ **Externer stummgeschalteter Kompressor (Optional)**

- ▢ **Pompa per il vuoto integrata da 70 m³/h**
- ⊗ **Integrated 70 m³/h vacuum pump**
- ▢ **Integrierte 70 m³/h Vakuumpumpe**

- ▢ **Filtri pompa liquidi e polveri (optional)**
- ⊗ **Vacuum pump filters dust, liquids (optional)**
- ▢ **Staub- und Flüssigkeitsfilter für die Pumpe (Optional)**

- ▢ **Pompa uso ossigeno (optional)**
- ⊗ **Pump suitable for oxygen (optional)**
- ▢ **Pumpe geeignet für Oxygen (Optional)**

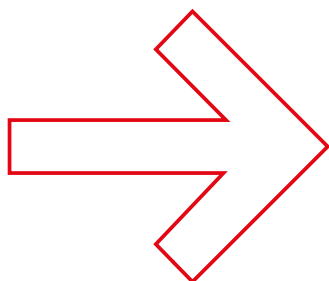
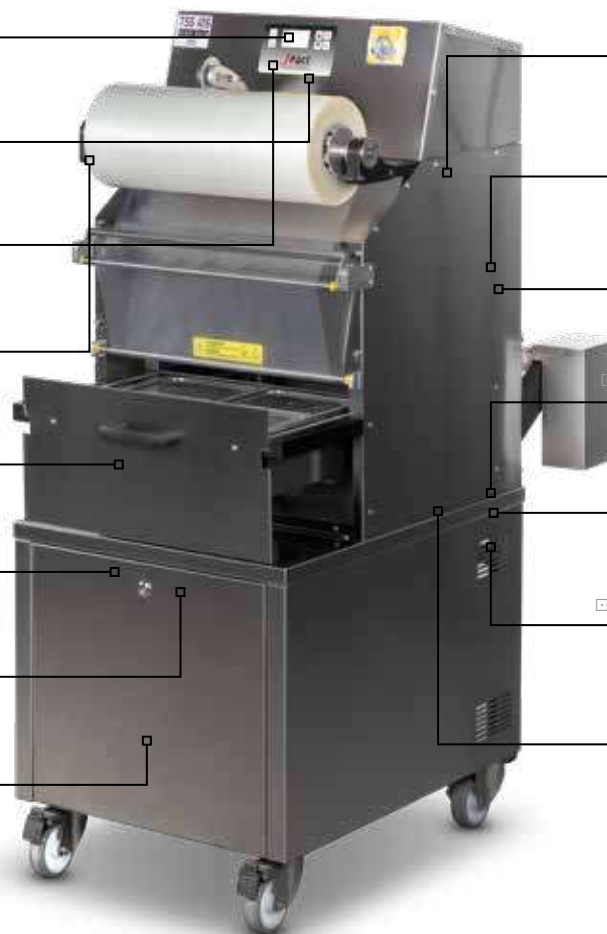

TSS126-OVERSKIN

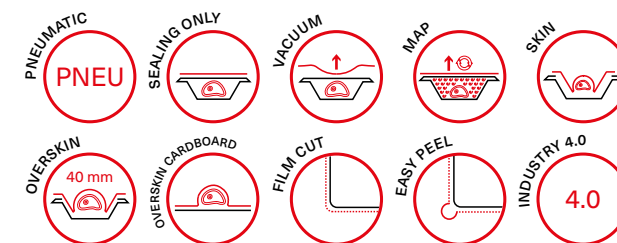

◊ Grazie alla tecnologia OVERSKIN, la termosigillatrice semi-automatica pneumatica TSS126 offre molteplici soluzioni, oltre all'imballaggio MAP e SKIN in vaschetta, anche il confezionamento di quei particolari prodotti, come tagli di carne pregiati o crostacei, con volumi importanti, fino a 40mm di protuberanza.

◊ Thanks to the OVERSKIN technology, the pneumatic semiautomatic thermosealing machine TSS126 offers multiple sealing options. In addition to MAP and SKIN tray packaging, it is also possible to seal special products such as fine cuts of meat or shellfish with protrusion up to 40 mm.

◻ Dank der OVERSKIN-Technologie bietet die pneumatische halbautomatische Siegelmaschine TSS126 mehrere Lösungen. Zusätzlich zu MAP- und SKIN-Verpackung in Schalen ist auch das Verpacken von bestimmten Produkten mit hervorstehenden Teilen bis zu 40 mm, wie feine Fleischstücke und Krebstiere, in Schalen und auf Karton möglich.



Modello	Model	Modell	TSS126-OVERSKIN
Dim. macchina / Peso	Machine sizes / Weight	Größe / Gewicht	680 x 970 h 1500 mm / 190 kg
Voltaggio-assorbimento	Voltage-absorption	Spannung-Absorption	380 V – 3,5 kW
Consumo aria	Air consumption	Luftverbrauch	10 NI/c
Pressione aria	Air pressure	Luftdruck	6-8 bar
Alimentazione gas	Gas feeding	Gasversorgung	3 bar
Dim. max vaschette	Tray max sizes	Max. Schalengröße	280 x 420 h 100 mm (Optional 150)
Dimensione max film (con recupero sfrido)	Max reel dimension (with scraps recovery)	Max Foliengröße (mit Folienausstanzung)	L= 480 - Ø 250 mm
Cicli/minuto	Cycles/minute	Zyklen/Minute	3-8

🏠 Tecnologia OVERSKIN

🚫 OVERSKIN technology

📦 OVERSKIN Technologie

◊ La tecnologia OVERSKIN offre la possibilità di lavorare con il nuovo sistema di confezionamento su cartoncino con grafica personalizzabile, per una sigillatura innovativa dal forte impatto estetico. Grazie al sistema di apertura facilitato, è possibile separare la pellicola protettiva dal cartoncino 100% riciclabile. Si tratta di una scelta sostenibile che permette di ridurre del 70% il consumo di plastica rispetto al tradizionale confezionamento in vaschetta.

◊ The OVERSKIN technology offers the possibility of working with our innovative packaging system. A flat cardboard with a fully customizable graphic for an excellent aesthetic finish. Thanks to the easy opening system, it is possible to separate the protective film cover from the 100% recyclable cardboard. It is a sustainable choice that allows reducing the plastic consumption to 70% compared to traditional tray packaging.

◻ Die OVERSKIN Technologie bietet die Möglichkeit mit einem Kartonverpackungssystem mit personalisierbarer Graphik zu arbeiten. Das Ergebnis ist eine innovative Versiegelung mit einer ausgezeichneten ästhetischen Ausführung. Dank des einfachen Öffnungssystems ist es möglich, die Folie vom vollständig recyclebaren Karton zu trennen. Es handelt sich um eine umweltfreundliche Wahl, die es erlaubt, den Kunststoffverbrauch im Vergleich zur traditionellen Schalenverpackung um 70% zu reduzieren.

TSS125-SKIN



☐ La termosigillatrice semi-automatica pneumatica TSS125-SKIN è una macchina carrellata pensata per il confezionamento SKIN in vaschetta.

☉ The pneumatic semiautomatic thermosealing machine TSS125-SKIN is a trolley-mounted machine designed for tray SKIN packaging.

☐ Der pneumatische halbautomatische Schalensiegler TSS125-SKIN ist eine Maschine mit Wagen, die speziell für die SKIN-Verpackung in Schalen entworfen wurde.

Dim. macchina / Peso	Machine sizes / Weight	Größe / Gewicht	595 x 750 (970) h 1490 mm / 170 kg
Dimensione max vaschetta	Tray max sizes	Max Schalengröße	280 x 420 h 100 mm (optional 150)

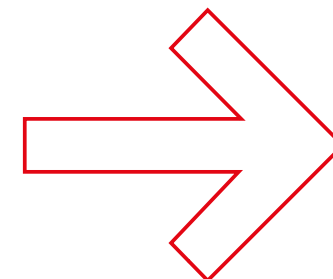
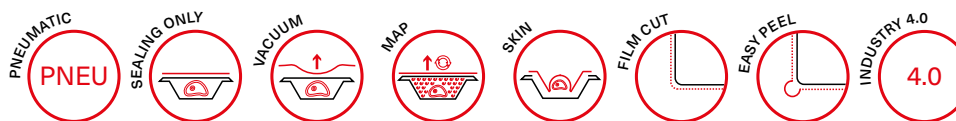

TSS136-SKIN



△ La nostra sigillatrice automatica TSS136 è disponibile anche in versione SKIN. Grazie all'amplia piastra saldante è possibile incrementare il numero di impronte, raddoppiando così la produttività.

⊙ Our compact automatic thermosealing machine TSS136 is also available in SKIN version. Thanks to the wide sealing plate it is possible to increase the number of cavities.

□ Unsere automatische Siegelmaschine TSS136 ist auch in Version SKIN erhältlich. Die breite Siegelplatte ermöglicht es, die Fächernummer zu steigern, dadurch die Produktivität verdoppelt wird.

Dim. macchina / Peso	Machine sizes / Weight	Größe / Gewicht	1130 x 760 h 1540 mm / 270 kg
Dimensione max vaschette	Tray max sizes	Max Schalengröße	280 x 390 h 100 mm

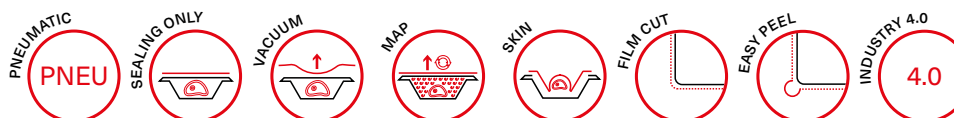

TSS145-SKIN



△ La nostra sigillatrice automatica TSS145 è disponibile anche in versione SKIN.

⊙ Our automatic thermosealing machine TSS145 is also available in SKIN version.

□ Unsere automatische Siegelmaschine TSS145 ist auch in Version SKIN erhältlich.

Dim. macchina / Peso	Machine sizes / Weight	Größe / Gewicht	mm 3200 x 877 h 1535 mm / 300 kg
Dimensione max vaschette	Tray max sizes	Max Schalengröße	280 x 390 h 100 mm (min 15)

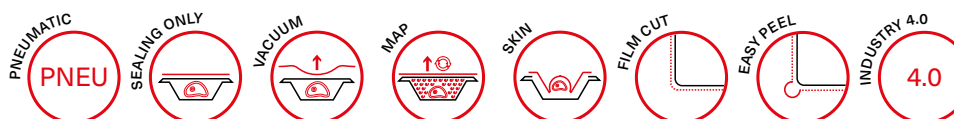

- 🏠 **Showroom virtuale**
- 🕒 **Virtual Showroom**
- 📄 **Virtueller Showroom**



- 🏠 Per una panoramica interattiva sulle nostre termosigillatrici, vi invitiamo a visitare la nostra showroom virtuale. Uno spazio 3D dove poter interagire con noi e le nostre macchine ovunque voi siate, con un solo click, direttamente dai vostri dispositivi.

- 🕒 For an interactive overview of our thermosealing machines, we invite you to visit our virtual showroom. An interactive 3D space where you can interact with our machines wherever you are with a single click, directly from your devices.

- 📄 Besuchen Sie unsere virtuelle Ausstellung, um einen Überblick über unsere Schalsiegler zu bekommen. Es handelt sich um einen 3D-Raum, in dem Sie mit uns und unseren Maschinen überall, mit einem Klick und direkt von Ihren Geräten aus interagieren können



- 🏠 **RICHIEDI UNA VISITA GUIDATA**
- 🕒 **REQUEST A GUIDED TOUR**
- 📄 **BUCHEN SIE EINE FÜHRUNG**

▶ T. +39 035 4521184
info@jpack.it



- 🏠 **Contatti**
- 🌐 **Contact**
- 📄 **Kontakt**

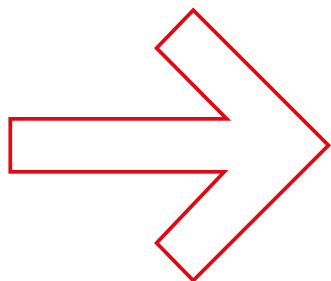

Headquarter

J Pack srl
Via Carminati, 30
24012 Val Brembilla (BG) Italy
Tel.+39.035.4521184

info@jpack.it
www.jpack.it

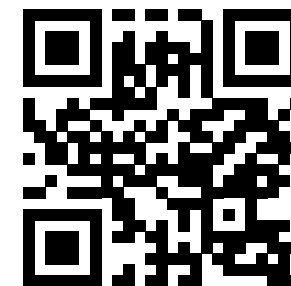

website

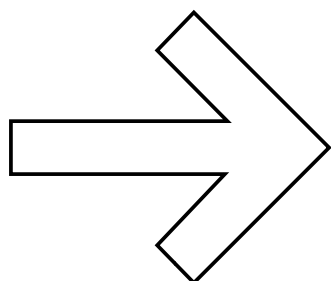

Branch Office&Showroom

J Pack srl
Via Alessandro Volta
24036 Ponte San Pietro (BG) Italy
Tel.+39.035.4521184

info@jpack.it
www.jpack.it



J Pack srl
Via Carminati, 30
24012 Val Brembilla (BG) Italy
Tel. +39.035.4521184

info@jpack.it
www.jpack.it

MADE IN ITALY
J **PACK**
Packaging Machines



△ **Distribuito da**
○ **Distributed by**
□ **Verteilt von**